

Mono Plus 20 is an economical and stylish three-compartment trunking, compact in size and designed to fit within areas that may have trunking height restrictions.

Product information

- 140 x 50mm
- 1 main compartment and 2 smaller outer compartments
- Can be sub-divided
- Suitable for dado application

Data information

- Standard bend radius 25mm (Cat 6)
- Adjustable data box 32-40mm
- Screened divider and data boxes

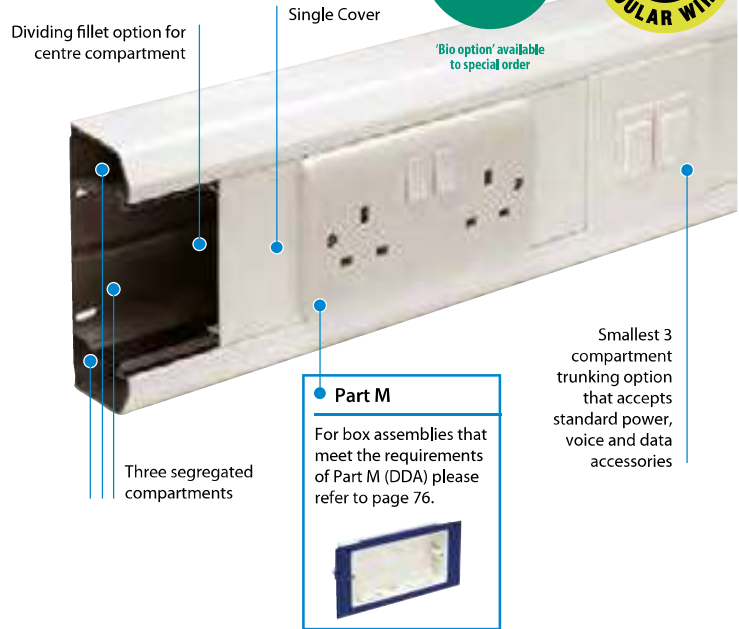

Standard colour
WH
WH: White

Part M

For box assemblies that meet the requirements of Part M (DDA) please refer to page 76.

Smallest 3 compartment trunking option that accepts standard power, voice and data accessories

Basic components

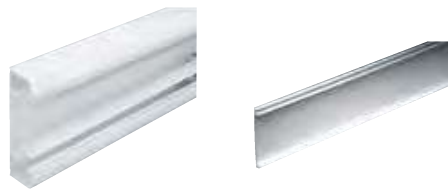

Trunking base

code	pack
EMT20WH	4 x 3m

Main compartment cover

code	pack
ETL1WH	8 x 3m

p228

Technical Information

Fittings



Coupler

code	pack
EC20WH	5

End cap

code	pack
EEC20WH	5

Internal bend ...DATA...

code	pack
EIB20WH	5

External bend ...DATA...

code	pack
EXB20WH	5



Dividing fillet

code	pack
EDF1	8 x 3m

Flat angle - up/down

code	pack
EFA20WH	1
Fabricated	

Slow bend ...DATA...

code	pack
EFA20SBWH	1
Fabricated	

PVC-U PERIMETER TRUNKING SYSTEMS

Fittings



Flat tee – up/down

code	pack
EFT20WH	1

Fabricated



Flat tee Gusseted ...DATA...

code	pack
EFT20GTWH	1

Fabricated

Components



***RCD/MCB Housing**

code	pack
EAHC1MWH	1



Main crossover bridge

code	pack
EMCB1	5



Main cable retainer

code	pack
EMCR1	10

*Up to 4 modules can be accommodated
Note: RCDs are not supplied by Marshall-Tufflex

Boxes and plates



1 gang accessory box

code	depth	pack
ESSB1WH	30mm	20



2 gang accessory box

code	depth	pack
ESSB2WH	30mm	10



1 gang adjustable depth box

code	depth	pack
EAB1WH	32 – 40mm	10

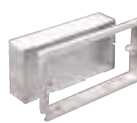

2 gang adjustable depth box

code	depth	pack
EAB2WH	32 – 40mm	5



1 gang accessory plate

code	pack
ESSP1WH	10



2 gang accessory plate

code	pack
ESSP2WH	5

Part M

1 and 2 gang box assemblies with contrasting coloured flush plates are available to comply with the requirements of Part M (DDA).



code	description	pack
ESPM1BU	1 gang - blue plate	1
ESPM1CH	1 gang - charcoal plate	1
ESPM1RD	1 gang - red plate	1
ESPM1GN	1 gang - green plate	1
ESPM1LG	1 gang - light grey plate	1
ESPM2BU	2 gang - blue plate	1
ESPM2CH	2 gang - charcoal plate	1
ESPM2RD	2 gang - red plate	1
ESPM2GN	2 gang - green plate	1
ESPM2LG	2 gang - light grey plate	1

Mono Plus 30 is an economical and stylish three-compartment compact skirting system, particularly suitable for general office applications.

Product information

- 155 x 55mm
- 1 main compartment and 2 smaller outer compartments
- Can be sub-divided
- Suitable for skirting or worktop application

Data information

- Standard bend radius 25mm (Cat 6)
- Adjustable data box 32-40mm
- Screened divider and data boxes



Dividing fillet option for centre compartment

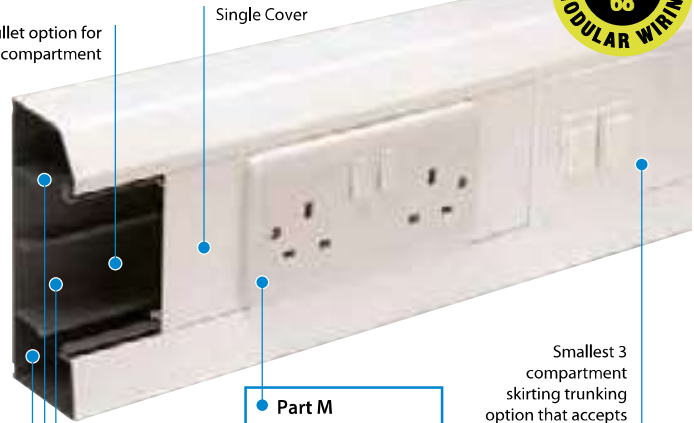

Smallest 3 compartment skirting trunking option that accepts standard power, voice and data accessories

Part M

For box assemblies that meet the requirements of Part M (DDA) please refer to page 78.

Standard colour
WH
WH: White

Basic components



Trunking (including 2 segregators)

code	pack
EMT30WH	4 x 3m



Main compartment cover

code	pack
ETL1WH	8 x 3m

p228

Technical Information

Fittings



Coupler

code	pack
EC30WH	5



End cap

code	pack
EEC30LHWH (left hand)	5
EEC30RHWH (right hand)	5



Internal bend DATA

code	pack
EIB30WH	5



External bend DATA

code	pack
EXB30WH	5



Dividing fillet

code	pack
EDF30	8 x 3m



Flat angle – upward

code	pack
EFA30UWH	1
Fabricated	



Flat angle – downward

code	pack
EFA30DWH	1
Fabricated	

PVC-U PERIMETER TRUNKING SYSTEMS

Fittings



Flat tee – upward

code	depth	pack
EFT30ULWH		1
Fabricated		



Flat tee – downward

code	depth	pack
EFT30DLWH		1
Fabricated		

Components



***RCD/MCB Housing**

code	depth	pack
EAHC1MWH		1



Main crossover bridge

code	depth	pack
EMCB1		5



Main cable retainer

code	depth	pack
EMCR1		10

*Up to 4 modules can be accommodated
Note: RCDs are not supplied by Marshall-Tufflex

Boxes and plates



1 gang accessory box

code	depth	pack
ESSB1WH	30mm	20



2 gang accessory box

code	depth	pack
ESSB2WH	30mm	10



...DATA...

1 gang adjustable depth box

code	depth	pack
EAB1WH	32 – 40mm	10



...DATA...

2 gang adjustable depth box

code	depth	pack
EAB2WH	32 – 40mm	5



1 gang accessory plate

code	depth	pack
ESSP1WH		10



2 gang accessory plate

code	depth	pack
ESSP2WH		5

Part M

1 and 2 gang box assemblies with contrasting coloured flush plates are available to comply with the requirements of Part M (DDA).

code	description	pack
ESPM1BU	1 gang - blue plate	1
ESPM1CH	1 gang - charcoal plate	1
ESPM1RD	1 gang - red plate	1
ESPM1GN	1 gang - green plate	1
ESPM1LG	1 gang - light grey plate	1
ESPM2BU	2 gang - blue plate	1
ESPM2CH	2 gang - charcoal plate	1
ESPM2RD	2 gang - red plate	1
ESPM2GN	2 gang - green plate	1
ESPM2LG	2 gang - light grey plate	1



Compact 1 is a small, fully segregated two compartment trunking system with a chamfered top profile. This trunking is suited to fit within areas where physical outside dimensions are important, for example, to negotiate above or below radiators and window sills.



'Bio option' available to special order



Product information

- 130 x 50mm
- 1 full and 1 half size compartment
- For dado installation
- Can be sub-divided

Data information

- Standard bend radius 25mm (Cat 6)
- Data fittings available for bend radius up to 50mm
- Compact 1 and 2 small compartment can be screened against EMI with no reduction in cable capacity
- Adjustable data box 32-40mm
- Screened divider and data boxes
- Steel divider available

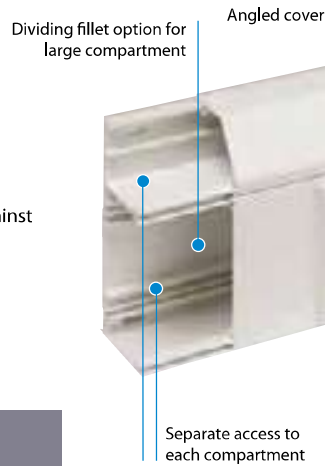

Part M

For box assemblies that meet the requirements of Part M (DDA) please refer to page 80.

Standard colour
WH
WH: White

p226

Technical Information

Basic components



Compact 1

size	130 x 50mm
------	------------



Base unit

code	ETB2WH	pack	4 x 3m
------	--------	------	--------



Main compartment cover

code	ETL1WH	pack	8 x 3m
------	--------	------	--------



Angled cover

code	ETAC1WH	pack	8 x 3m
------	---------	------	--------

Fittings



Compact 1 Couplers

code	description	pack
ECC1WH	2 piece	5
ECHC1WH	1 piece	5



Compact 1 End caps LH & RH

code	description	pack
EECC1LHWH	2 piece	5
EECC1RHWH	2 piece	5
EECHC1LHWH	1 piece	5
EECHC1RHWH	1 piece	5



Dividing fillet

code	EDF1	pack	8 x 3m
------	------	------	--------



Compact 1 Flat angle upward

code	EFAC1UWH	pack	1
------	----------	------	---



Compact 1 flat angle downward

code	EFAC1DWH	pack	1
------	----------	------	---



Bonding strap

code	ESBS1	pack	5
------	-------	------	---



Steel screening divider

code	ESF1	pack	1
------	------	------	---

Note: optional steel screening divider to assist in compliance with BS EN 50174-2



Steel screening divider bonding strap

code	ESF2	pack	5
------	------	------	---

Compact 1 flat tees

Compact 1 flat tees are handed to the left or to the right side. For the product you require, please order the following:

Left upward = EFTC1ULWH
 Left downward = EFTC1DLWH
 Right upward = EFTC1URWH
 Right downward = EFTC1DRWH

For further advice please call the Technical Team on 01424 856688.

PVC-U PERIMETER TRUNKING SYSTEMS

Fittings



Compact 1 Internal bend

code	description	pack
EIBC1WH	2 piece	5
EIBHC1WH	1 piece	5



Compact 1 External bend

code	description	pack
EXBC1WH	2 piece	5
EXBHC1WH	1 piece	5



Compact 1 Internal bend assembly ...DATA...

code	description	pack
ELIBCD1WH	assemblies	1
EIBCD1WH	covers only	1



Compact 1 External bend assembly ...DATA...

code	description	pack
EL0BCD1WH	assemblies	1

Components



***RCD/MCB housing**

code	pack
EAHC1MWH	1

*Up to 4 modules can be accommodated
Note: RCDs are not supplied by Marshall-Tufflex



Main crossover bridge

code	pack
EMCB1	5

Provides segregation of services crossing from one compartment to another



Angled cable retainer

code	pack
EACR1	10

Provides cable retention in the upper angled or square compartment. For skirting application use cable tray



Main cable retainer

code	pack
EMCR1	10

The recommended cable retainer for all compartments which use the ETL1WH lid



Angled mini-trunking adapter

code	size	pack
EATA2WH	MMT2	5

Allows the transfer of cables from Compact 1 to Marshall-Tufflex Mini-Trunking



Angled mini-trunking adapter

code	size	pack
EATA4WH	MMT4	5

Allows the transfer of cables from Compact 1 to Marshall-Tufflex Mini-Trunking

Boxes and plates



1 gang accessory box

code	depth	pack
ESSB1WH	30mm	20



2 gang accessory box

code	depth	pack
ESSB2WH	30mm	10

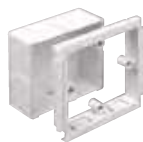

1 gang adjustable depth box ...DATA...

code	depth	pack
EAB1WH	32 - 40mm	10



2 gang adjustable depth box ...DATA...

code	size	pack
EAB2WH	32 - 40mm	5



1 gang accessory plate

code	pack
ESSP1WH	10



2 gang accessory plate

code	pack
ESSP2WH	5

Part M

1 and 2 gang box assemblies with contrasting coloured flush plates are available to comply with the requirements of Part M (DDA).



code	description	pack
ESPM1BU	1 gang - blue plate	1
ESPM1CH	1 gang - charcoal plate	1
ESPM1RD	1 gang - red plate	1
ESPM1GN	1 gang - green plate	1
ESPM1LG	1 gang - light grey plate	1
ESPM2BU	2 gang - blue plate	1
ESPM2CH	2 gang - charcoal plate	1
ESPM2RD	2 gang - red plate	1
ESPM2GN	2 gang - green plate	1
ESPM2LG	2 gang - light grey plate	1