

BANDEX Cable Accessories

CABLE MARKERS



CM TYPE CALBE MARKER

Unit: mm

Part No.	Wires suitable		Std. Markings	Packing
	Sq	mm		
CM-0.75	0.75	3.0	0,1,2,3, ...9 A,B,C, ...Z, +, -, ≡,/, blank	100pcs/bag
CM-1.25	1.25	3.2		
CM-2.0	2.0	3.6		
CM-3.5	3.5	4.2		
CM-5.5	5.5	5.1		
CM-8	8	6.2		



- Material: Rigid PVC
- Clip on design.
- Can be applied after wire termination.
- Maximum service temp: 85°C

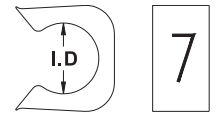

SIDE ON TYPE MARKER

Unit: mm

Part No.	Suitable Wire sq	Size			Std. Markings	Packing
		L	Ø1	Ø2		
VS-1	0.95~1.3	2.3	0.9	1.7	+, - 0, 1, 2, ... 9 A,B,C,...Z	30 pcs/stick
S-1	0.5	3.0	1.8	2.8		
N-1	0.75	3.0	2.7	3.9		
	0.9					
N-2	1.25	3.0	3.2	4.6		
	2.0					
N-3	3.5	3.0	4.4	5.8		
	5.5					

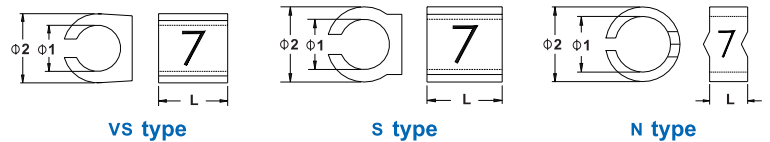
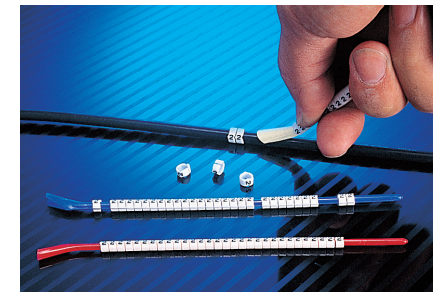

MARKER STRIPS

Unit: mm

Part No.	L	W	T	Available loaded quantity of GM-1 Cable Marker	Length
MS-65	65	9	6.7	9pcs	100pcs
MS-100	100	9	6.95	16pcs	
MS-135	135	9	7	23pcs	
MS-135L	135	9	13	23pcs	

- NYLON 66 PLATE with cable tie fastening hole to accommodate marker pieces for easy identification of cable runs.

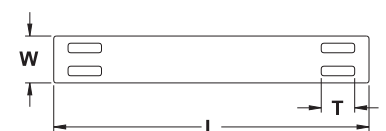

MARKER BOX

Unit: mm

Part No.	Available loaded quantity of BM Cable Marker	Material
BMB-1	13 pcs	Acrylic



OM TYPE MARKER

Unit: mm

Part No.	Cable Dia		L	Std. Markings	Packing
	Sq	mm			
OM-22S	22	1.3	10	OM-1.25 OM-2.0 0,1,2, ...100 A,B, ...Z +,-,≡,/, blank	100pc
OM-20S	20	1.5			
OM-18S	18	1.8			
OM-16S	16	1.9			
OM-0.75	0.75	3.0			
OM-1.25	1.25	3.2			
OM-2.0	2.0	3.6			
OM-3.5	3.5	4.2			
OM-5.5	5.5	5.1			
OM-8	8	6.2			
OM-14	14	7.6			
OM-22	22	9.1			

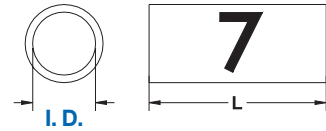

- Material: Soft PVC
- Sleeve on design.
- Apply before wire termination.

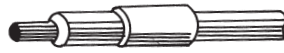

3

* Special Marking is available upon request.

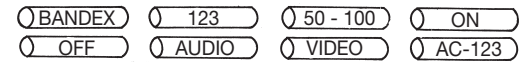

FLAT MARKER TUBE

Unit: mm

Part No.	OUT Dia	Cable Dia	Packing
FMR-3	3.5	2	100M/roll
FMR-4	4.8	3	
FMR-6	6.8	4.2	
FMR-8	8.0	5	
FMR-13	13.0	8	
FMR-18	18.0	11	50M/roll



- Material: Soft PVC

U TYPE CABLE MARKER

Unit: mm

Part No.	Suitable wire sq	L	H	W	W1	Packing
UM-1	1.25~2.0	12.6	4.3	4.4	3.0	100pcs

- Material: PP
- Color: Pink (PK1), Blue (BE1), Yellow (YW1), Green (GN1), Purple (VT1).
- Different colors for easy verification of wire function.

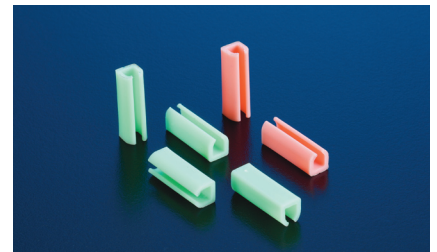
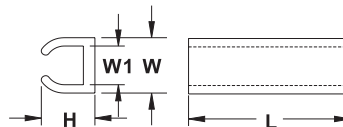

GM TYPE MARKERS

Unit: mm

Part No.	Cable Dia		Marker Length	Std. Markings	Packing
	sq	mm			
GM-1	2~8	3.5~7.0	5	0,1,2,3, ...9 A,B,C, ...Z, +,-,≡,/, blank	500pcs

- GM CABLE MARKER with its unique oval shape design provide
 - 1.slip over cable directly (for small cable)
 - 2.slip onto marker strip (for larger cable or cable bundles)



O TYPE MARKER TUBE

Unit: mm

Part No.	Cable Dia		Packing
	Sq	mm	
OMR-0.75	0.75	3.0	100M/roll
OMR-1.25	1.25	3.2	
OMR-2.0	2.0	3.6	
OMR-3.5	3.5	4.2	
OMR-5.5	5.5	5.1	
OMH-1.25	1.25	3.2	500M/roll
OMH-2.0	2.0	3.6	
OMH-3.2	3.5	4.2	
OMK-0.75	0.75	3.0	1000M/box
OMK-1.25	1.25	3.2	
OMK-2.0	2.0	3.6	



- Material: Soft PVC

Part No.	Cable Dia	Packing
OMJ-1.5	2.8	200M/roll
OMJ-2.5	4.0	
OMJ-4.0	4.5	



- Material: Soft PVC (bright White)
- Color available in bright Yellow, bright red.

Part No.	Cable Dia	Packing
OMT-2.5	2.5	200M/roll
OMT-3.0	3.0	
OMT-3.2	3.2	
OMT-3.5	3.5	
OMT-4.0	4.0	
OMT-4.5	4.5	
OMT-5.0	5.0	100M/roll
OMT-5.5	5.5	

- Material: Soft PVC

OC TYPE CABLE MARKER

Unit: mm

Part No.	Wires suitable		Std. Markings	Packing
	Sq	mm		
OC-1	0.5~0.75	2.5~3.0	0,1,2,3, ...9 A,B,C, ...Z, +, -, ≡, /, blank	1000 pcs
OC-2	1.25~2.0	3.2~3.6		
OC-2L	1.25~2.0	3.2~3.6		
OC-3	3.5~5.5	4.2~5.1		500pcs
OC-4	5.5~8.0	5.1~6.2		300pcs
OC-8	14.0	7.5~8.0		

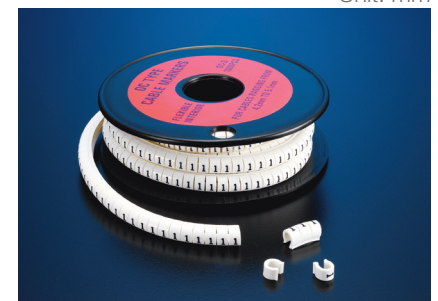

- Material: Rigid PVC
- Maximum service temperature: 85°C
- Standard color: White body marker in black.

Description

- To be fitted after termination. May be removed without breaking the terminal connection.
- O shape design to prevent marker conflict of close wire termination.
- Clip on design enable it to grip wire/cable firmly in position after termination attached.
- Each marker will accommodate multiple wire sizes.

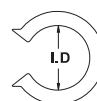

Standard design



OC-8

MARKER PLATE

Unit: mm

Part No.	L	W	T	Packing
MP-1626	26	15.2	1.2	100pcs/bag
MP-2040	42.2	21.2	1.2	
MP-2560	60.8	25.2	1.2	
MP-5060	62.2	51.5	1.3	
MP-1938	38.5	19.1	0.4	
MP-1944	45.3	19.1	0.4	
MP-5019	50.5	19.1	0.4	
MP-1963	65	19.1	0.4	
MP-6344	63.8	44.8	0.4	
MP-8819	90.0	19.1	0.4	



- Material: Nylon. (Natural)
- Used to mark cable bundles for permanent identification.
- Secured with cable ties extensively from CT075-2C to CT200-4C in variety of ways.

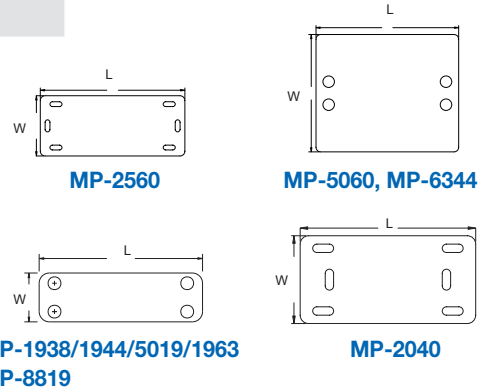

SELF ADHESIVE WIRE MARKER

Unit: mm

Part No.	L	W	Std. Markings	Packing
WM-1	25	6.5	Solid: 0, 1, 2, 3, ... 9 10, 11, 12, ... 100 A, B, C, ... Z, +, -, = Consecutive Number: 0~9, 1~34, 35~67, 68~100, A~Z	50pcs/box
WM-2	25	6.5	blank	50pcs/box
WM-3	40	10		
WMB-1	25	6.5	0~9@1page	
WMB-2	25	6.5	(A~Z, /, +, -, 0~15) × 10page	
WMB-3	25	6.5	(1~45) × 10page	

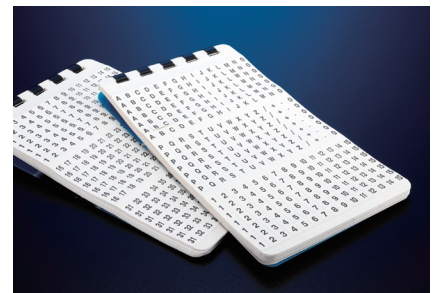
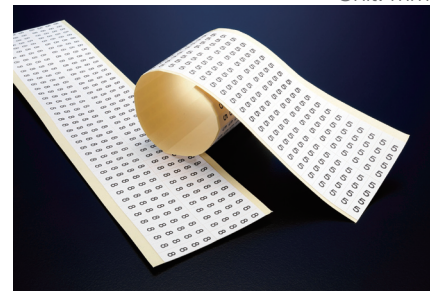

BOOK SIZE: L: 143 W: 82

- Stick to wires for permanent identification.
- Used extensively for cable diameters after or before terminal is attached.
- Cloth type label.
- For your orders, please specify solid or consecutive and what letter (s), number (s) you need.
For example: Solid: WM-1 1.2.A,B,...10pcs each.
consecutive: WM-1 0-9, A-Z,...10pcs each.

