

### 501001 HYDROBLADE COMPACT ROUND LED

Recessed round luminaire for outdoor installation in the wall, phospho-chromatised and polyester powder coated die-cast copper-free aluminium body, stainless steel AISI 304 frame, tempered safety glass, moulded silicone gasket and stainless steel screws. Built-in LED driver 220-240V 50-60Hz, with 1 high-power LED. IP65 rating.

#### Energy Label **A++**

- Material: high corrosion resistance die-cast copper-free aluminum body
- Coating: polyester powder coating with phosphochromating pre-finish
- Stainless steel AISI 304 trim.
- NR, 1 x 1W LED
- Electronic transformer 220/240V 50/60Hz included
- Stainless steel screws
- Silicone rubber gasket
- Tempered safety glass.
- Protection against impact IK09 (10 joule)
- Double cable gland PG11
- Polypropilene recessing box included.
- 1 mt. neoprene power cable included

2 WATT  
220-240V 50-60HZ ELECTRONIC  
IP65  
1.40 KG UNIT GROSS WEIGHT

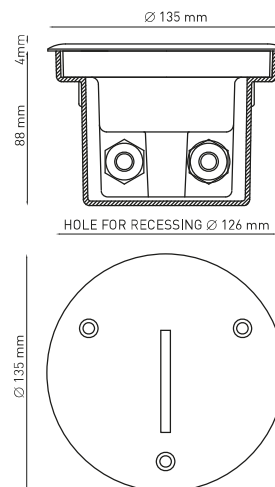

LIGHT SOURCE	LED COLOR*	LIGHT BEAM OPTIONS	LUMEN OUTPUT (lm)	LUMINOUS EFFICACY (lm/w)	COLORS OPTIONS
HIGH-POWER LED	3.000°K WARM-WHITE	SPOT DIRECTIONAL	96	48.00	STAINLESS STEEL
	6.000°K COLD-WHITE	SPOT DIRECTIONAL	100	50.00	

\* OTHER LIGHT COLORS AVAILABLE ON REQUEST: ● BLUE

### 501002 HYDROBLADE COMPACT SQUARE LED

Recessed square luminaire for outdoor installation in the wall, phospho-chromatised and polyester powder coated die-cast copper-free aluminium body, stainless steel AISI 304 frame, tempered safety glass, moulded silicone gasket and stainless steel screws. Built-in LED driver 220-240V 50-60Hz, with 1 high-power LED. IP65 rating.

#### Energy Label **A++**

- Material: high corrosion resistance die-cast copper-free aluminum body
- Coating: polyester powder coating with phosphochromating pre-finish
- Stainless steel AISI 304 trim.
- NR, 1 x 1W LED
- Electronic transformer 220/240V 50/60Hz included
- Stainless steel screws
- Silicone rubber gasket
- Tempered safety glass.
- Protection against impact IK09 (10 joule)
- Double cable gland PG11
- Polypropilene recessing box included.
- 1 mt. neoprene power cable included

2 WATT  
220-240V 50-60HZ ELECTRONIC  
IP65  
1.40 KG UNIT GROSS WEIGHT

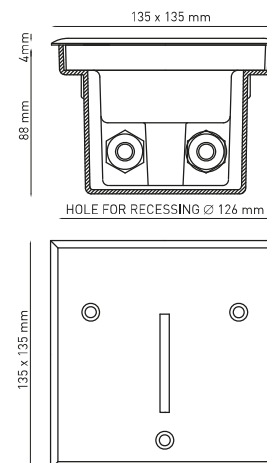

LIGHT SOURCE	LED COLOR*	LIGHT BEAM OPTIONS	LUMEN OUTPUT (lm)	LUMINOUS EFFICACY (lm/w)	COLORS OPTIONS
HIGH-POWER LED	3.000°K WARM-WHITE	SPOT DIRECTIONAL	96	48.00	STAINLESS STEEL
	6.000°K COLD-WHITE	SPOT DIRECTIONAL	100	50.00	

\* OTHER LIGHT COLORS AVAILABLE ON REQUEST: ● BLUE



**502014 HYDROSTEP – TONDO – T 03 LED**

Recessed round steplight for outdoor installation in the wall, phospho-chromatised and polyester powder coated die-cast copper-free aluminium body and frame, tempered safety glass, moulded silicone gasket and stainless steel screws. Built-in LED driver 220-240V 50-60Hz, with 1 high-power CREE LED. IP65 rating.

**Energy Label A++**

- Material: high corrosion resistance die-cast copper-free aluminum body
- Coating: polyester powder coating with phosphochromating pre-finish
- NR. 1 x 1W CREE LED
- Electronic transformer 220/240V 50/60Hz included
- Stainless steel screws
- Silicone rubber gasket
- Protection against impact IK09 (10 joule)
- Polypropilene recessing box included.
- 0.2 mt. neoprene power cable included

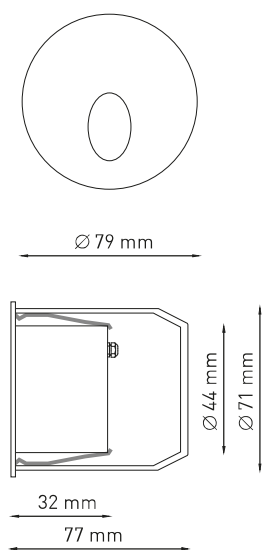

	LIGHT SOURCE	LED COLOR*	LIGHT BEAM OPTIONS	LUMEN OUTPUT (lm)	LUMINOUS EFFICACY (lm/w)	COLORS OPTIONS
1 WATT 220-240V 50-60HZ ELECTRONIC IP65 0.60 KG UNIT GROSS WEIGHT	HIGH-POWER LED	3.000°K WARM-WHITE	80° ASYMMETRIC	60	60.00	TEXTURED GREY

**502015 HYDROSTEP – QUADRO – Q 03 LED**

Recessed round steplight for outdoor installation in the wall, phospho-chromatised and polyester powder coated die-cast copper-free aluminium body and frame, tempered safety glass, moulded silicone gasket and stainless steel screws. Built-in LED driver 220-240V 50-60Hz, with 1 high-power CREE LED. IP65 rating.

**Energy Label A++**

- Material: high corrosion resistance die-cast copper-free aluminum body
- Coating: polyester powder coating with phosphochromating pre-finish
- NR. 1 x 1W CREE LED
- Electronic transformer 220/240V 50/60Hz included
- Stainless steel screws
- Silicone rubber gasket
- Protection against impact IK09 (10 joule)
- Polypropilene recessing box included.
- 0.2 mt. neoprene power cable included

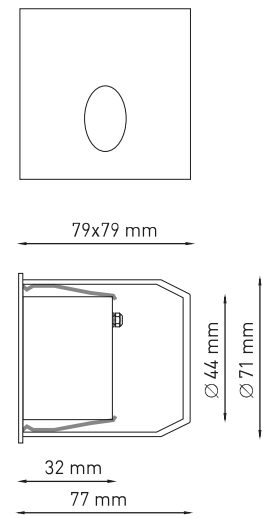





	LIGHT SOURCE	LED COLOR*	LIGHT BEAM OPTIONS	LUMEN OUTPUT (lm)	LUMINOUS EFFICACY (lm/w)	COLORS OPTIONS
1 WATT 220-240V 50-60HZ ELECTRONIC IP65 0.60 KG UNIT GROSS WEIGHT	HIGH-POWER LED	3.000°K WARM-WHITE	80° ASYMMETRIC	60	60.00	TEXTURED GREY

**502001P HYDROSTEP T/01 TONDO**

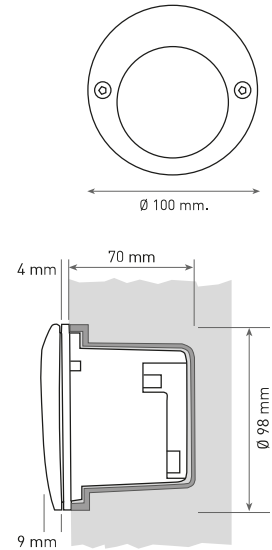
Recessed round steplight for outdoor installation in the wall, phospho-chromatised and polyester powder coated die-cast copper-free aluminium body and frame, tempered safety glass, moulded silicone gasket and stainless steel screws. Remote transformer needed, G4 20W LED / halogen. IP65 rating.

- Material: high corrosion resistance die-cast copper-free aluminum body
- Coating: polyester powder coating with phosphochromating pre-finish
- 2 pins G4 base, MAX 20W
- Stainless steel screws
- Silicone rubber gasket
- Tempered safety fully frosted glass.
- Protection against impact IK09 (10 joule)
- Polypropilene recessing box included.







	LIGHT SOURCE	LIGHT COLOR	LIGHT BEAM OPTIONS	COLORS OPTIONS
20 WATT MAX 12V IP54 0.50 KG UNIT GROSS WEIGHT	 G4 LED / HALOGEN	SEE BULB FEATURES	 FLOOD	 TEXTURED GREY

**502002P HYDROSTEP T/02 TONDO**

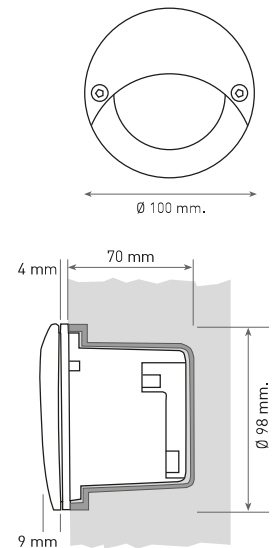
Recessed round steplight for outdoor installation in the wall, phospho-chromatised and polyester powder coated die-cast copper-free aluminium body and frame, tempered safety glass, moulded silicone gasket and stainless steel screws. Remote transformer needed, G4 20W LED / halogen. IP65 rating.

- Material: high corrosion resistance die-cast copper-free aluminum body
- Coating: polyester powder coating with phosphochromating pre-finish
- 2 pins G4 base, MAX 20W
- Stainless steel screws
- Silicone rubber gasket
- Tempered safety fully frosted glass.
- Protection against impact IK09 (10 joule)
- Polypropilene recessing box included.



	LIGHT SOURCE	LIGHT COLOR	LIGHT BEAM OPTIONS	COLORS OPTIONS
20 WATT MAX 12V IP54 0.50 KG UNIT GROSS WEIGHT	 G4 LED / HALOGEN	SEE BULB FEATURES	 FLOOD	 TEXTURED GREY





**502003P HYDROSTEP Q/05 QUADRO**

Recessed square steplight for outdoor installation in the wall, phospho-chromatised and polyester powder coated die-cast copper-free aluminium body and frame, tempered safety glass, moulded silicone gasket and stainless steel screws. Remote transformer needed, G4 20W LED / halogen. IP65 rating.

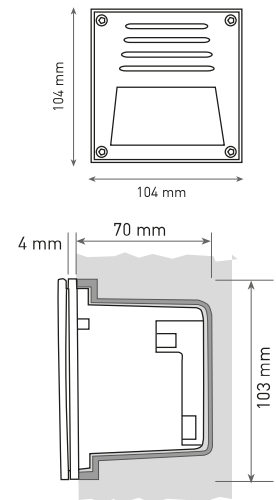
- Material: high corrosion resistance die-cast copper-free aluminum body
- Coating: polyester powder coating with phosphochromating pre-finish
- 2 pins G4 base, MAX 20W
- Stainless steel screws
- Silicone rubber gasket
- Tempered safety fully frosted glass.
- Protection against impact IK09 (10 joule)
- Polypropylene recessing box included.







	LIGHT SOURCE	LIGHT COLOR	LIGHT BEAM OPTIONS	COLORS OPTIONS
20 WATT MAX 12V IP54 0,60 KG UNIT GROSS WEIGHT	 G4 LED / HALOGEN	SEE BULB FEATURES	 DIRECTIONAL	 TEXTURED GREY

**502004P HYDROSTEP – ES/08 RETTANGOLO**

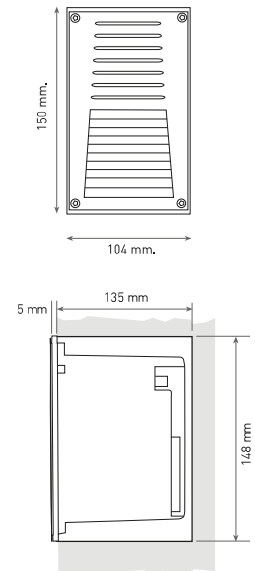
Recessed rectangular steplight for outdoor installation in the wall, phospho-chromatised and polyester powder coated die-cast copper-free aluminium body and frame, tempered safety glass, moulded silicone gasket and stainless steel screws. Built-in transformer 230V 50Hz G24d-1 10W compact fluorescent. IP65 rating.

- Material: high corrosion resistance die-cast copper-free aluminum body
- Coating: polyester powder coating with phosphochromating pre-finish
- Stainless steel screws
- Silicone rubber gasket
- Tempered safety fully frosted glass.
- Protection against impact IK09 (10 joule)
- Polypropylene recessing box included.







	LIGHT SOURCE	LIGHT COLOR	LIGHT BEAM OPTIONS	COLORS OPTIONS
10 WATT 230V 50HZ IP54 1.30 KG UNIT GROSS WEIGHT	 ES TC-D - G24D-1	SEE BULB FEATURES	 DIRECTIONAL	 TEXTURED GREY

**502007P HYDROSTEP – RETTANGOLO – GU10**

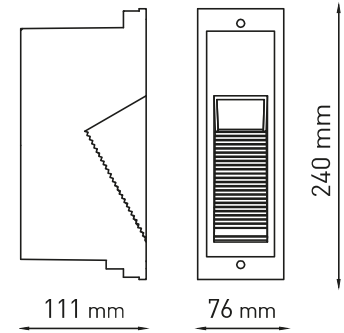
Recessed rectangular steplight for outdoor installation in the wall, phospho-chromatised and polyester powder coated die-cast copper-free aluminium body and frame, tempered safety glass, moulded silicone gasket and stainless steel screws. GU10 LED / halogen. IP65 rating.

- Material: high corrosion resistance die-cast copper-free aluminum body
- Coating: polyester powder coating with phosphochromating pre-finish
- Stainless steel screws
- Silicone rubber gasket
- Tempered safety glass.
- Protection against impact IK09 (10 joule)
- Polypropylene recessing box included.



	LIGHT SOURCE	LIGHT COLOR	LIGHT BEAM OPTIONS	COLORS OPTIONS
35 WATT MAX 220-240V 50-60HZ IP55 1.20 KG UNIT GROSS WEIGHT	 GU10 LED / HALOGEN	SEE BULB FEATURES	 DIRECTIONAL	 DARK-GREY

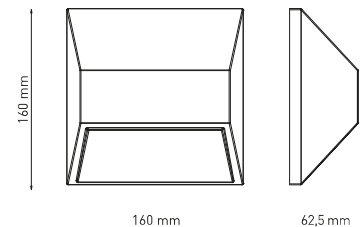

**502005 HYDROSTEP – QUADRO Q 01 LED**

Square steplight for outdoor surface installation on the wall, phospho-chromatised and polyester powder coated die-cast copper-free aluminium body, tempered safety glass, moulded silicone gasket and stainless steel screws. Built-in LED driver 220-240V 50-60Hz, with 3 high-power LED. IP65 rating.



**Energy Label** A++

- Material: high corrosion resistance die-cast copper-free aluminum body
- Coating: polyester powder coating with phosphochromating pre-finish
- NR, 3 x 1W CREE LED
- Electronic transformer 220/240V 50/60Hz included
- Stainless steel screws
- Silicone rubber gasket

	LIGHT SOURCE	LED COLOR*	LIGHT BEAM OPTIONS	LUMEN OUTPUT (lm)	LUMINOUS EFFICACY (lm/w)	COLORS OPTIONS
3 WATT 220-240V 50-60HZ ELECTRONIC IP55 0.90 KG UNIT GROSS WEIGHT	HIGH-POWER LED	 3,000°K WARM-WHITE	 10°	240	80.00	 MATT BLACK





**502006 HYDROSTEP – QUADRO Q 02 LED**



Square steplight for outdoor surface installation on the wall, phospho-chromatised and polyester powder coated die-cast copper-free aluminium body, tempered safety glass, moulded silicone gasket and stainless steel screws. Built-in LED driver 220-240V 50-60Hz, with 2 x 3 high-power LED. IP65 rating.

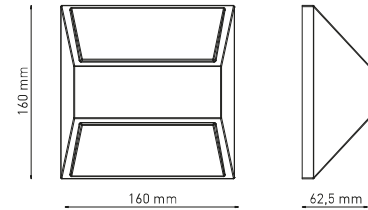

**Energy Label** A++

- Material: high corrosion resistance die-cast copper-free aluminum body
- Coating: polyester powder coating with phosphochromating pre-finish
- NR. 3 x 1W CREE LED up and NR. 3 x 1W CREE LED down.
- Electronic transformer 220/240V 50/60Hz included
- Stainless steel screws
- Silicone rubber gasket



	LIGHT SOURCE	LED COLOR*	LIGHT BEAM OPTIONS	LUMEN OUTPUT (lm)	LUMINOUS EFFICACY (lm/w)	COLORS OPTIONS
6 WATT 220-240V 50-60HZ ELECTRONIC IP55 1.00 KG UNIT GROSS WEIGHT	HIGH-POWER LED	 3.000°K WARM-WHITE	 10°	2 X 240	80.00	 MATT BLACK



**502018 HYDROSTEP – QUADRO – Q 04 LED**



Recessed linear steplight for outdoor installation in the wall, phospho-chromatised and polyester powder coated die-cast copper-free aluminium body and frame, tempered frosted glass diffuser, polypropilene housing for recess, moulded silicone gasket and stainless steel screws. Built-in LED driver 220-240V 50-60Hz, with 24 low-power SMD3528 LED. IP65 rating.



**Energy Label A++**

- Material: high corrosion resistance die-cast copper-free aluminum body and frame.
- Coating: polyester powder coating with phosphochromating pre-finish
- NR. 24 x SMD3528 LED
- Electronic transformer 220/240V 50/60Hz included
- Stainless steel screws
- Silicone rubber gasket
- Tempered safety glass.
- 0,50 mt. neoprene power cable included

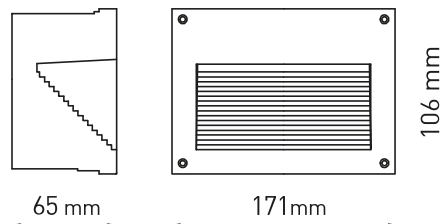

	LIGHT SOURCE	LED COLOR*	LIGHT BEAM OPTIONS	LUMEN OUTPUT (lm)	LUMINOUS EFFICACY (lm/w)	COLORS OPTIONS
3 WATT 220-240V 50-60HZ ELECTRONIC IP65 0,85 KG UNIT GROSS WEIGHT	SMD3528	3.000°K WARM-WHITE	120°	70	23.33	TEXTURED GREY

**502019 HYDROSTEP – QUADRO – Q 06 LED**



Recessed linear steplight for outdoor installation in the wall, phospho-chromatised and polyester powder coated die-cast copper-free aluminium body and frame, tempered frosted glass diffuser, polypropilene housing for recess, moulded silicone gasket and stainless steel screws. Built-in LED driver 220-240V 50-60Hz, with 18 low-power SMD3528 LED. IP65 rating.

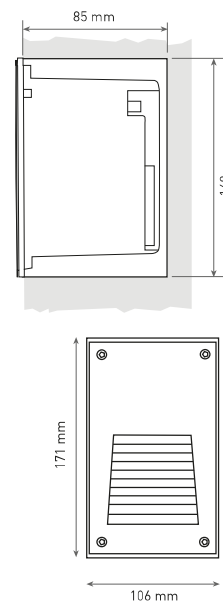

**Energy Label A++**

- Material: high corrosion resistance die-cast copper-free aluminum body and frame.
- Coating: polyester powder coating with phosphochromating pre-finish
- NR. 18 x SMD3528 LED
- Electronic transformer 220/240V 50/60Hz included
- Stainless steel screws
- Silicone rubber gasket
- Tempered safety glass.
- 0,50 mt. neoprene power cable included

	LIGHT SOURCE	LED COLOR*	LIGHT BEAM OPTIONS	LUMEN OUTPUT (lm)	LUMINOUS EFFICACY (lm/w)	COLORS OPTIONS
2 WATT 220-240V 50-60HZ ELECTRONIC IP65 0,90 KG UNIT GROSS WEIGHT	SMD3528	3.000°K WARM-WHITE	120°	50	25.00	TEXTURED GREY





**502008P HYDROSTEP – QUADRO – FLUO**

Recessed square steplight for outdoor installation in the wall, phospho-chromatised and polyester powder coated die-cast copper-free aluminium body and frame, tempered safety glass, moulded silicone gasket and stainless steel screws. Built-in transformer 230V 50Hz G24d-2 18W compact fluorescent. IP65 rating.

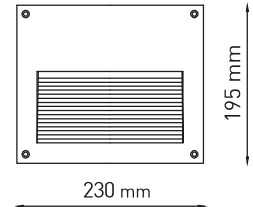
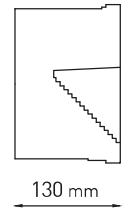
- Material: high corrosion resistance die-cast copper-free aluminum body
- Coating: polyester powder coating with phosphochromating pre-finish
- Stainless steel screws
- Silicone rubber gasket
- Tempered safety glass.
- Protection against impact IK09 (10 joule)
- Polypropylene recessing box included.





	LIGHT SOURCE	LIGHT COLOR	LIGHT BEAM OPTIONS	COLORS OPTIONS
18 WATT 230V 50HZ IP55 3.00 KG UNIT GROSS WEIGHT	TC-T 6X 24D-2 18W	SEE BULB FEATURES	 DIRECTIONAL	 MATT BLACK

**502009L HYDROSTEP – QUADRO – RX7S**

Recessed square steplight for outdoor installation in the wall, phospho-chromatised and polyester powder coated die-cast copper-free aluminium body and frame, tempered safety glass, moulded silicone gasket and stainless steel screws. Built-in ballast 230V 50Hz, Rx7s 70W metal halide. IP65 rating.

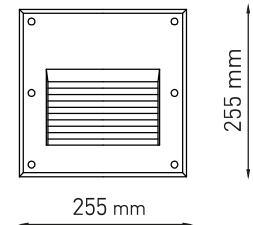
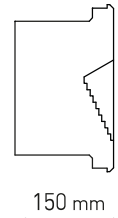
- Material: high corrosion resistance die-cast copper-free aluminum body
- Coating: polyester powder coating with phosphochromating pre-finish
- Stainless steel screws
- Conventional ballast 230V 50 Hz
- HIT-DE – Rx7s
- Silicone rubber gasket
- Tempered safety glass.
- Protection against impact IK09 (10 joule)
- Polypropylene recessing box included.



	LIGHT SOURCE	LIGHT COLOR	LIGHT BEAM OPTIONS	COLORS OPTIONS
70 WATT 230V 50HZ IP55 5.50 KG UNIT GROSS WEIGHT	HIT-DE – RX7S	SEE BULB FEATURES	 DIRECTIONAL	 MATT BLACK



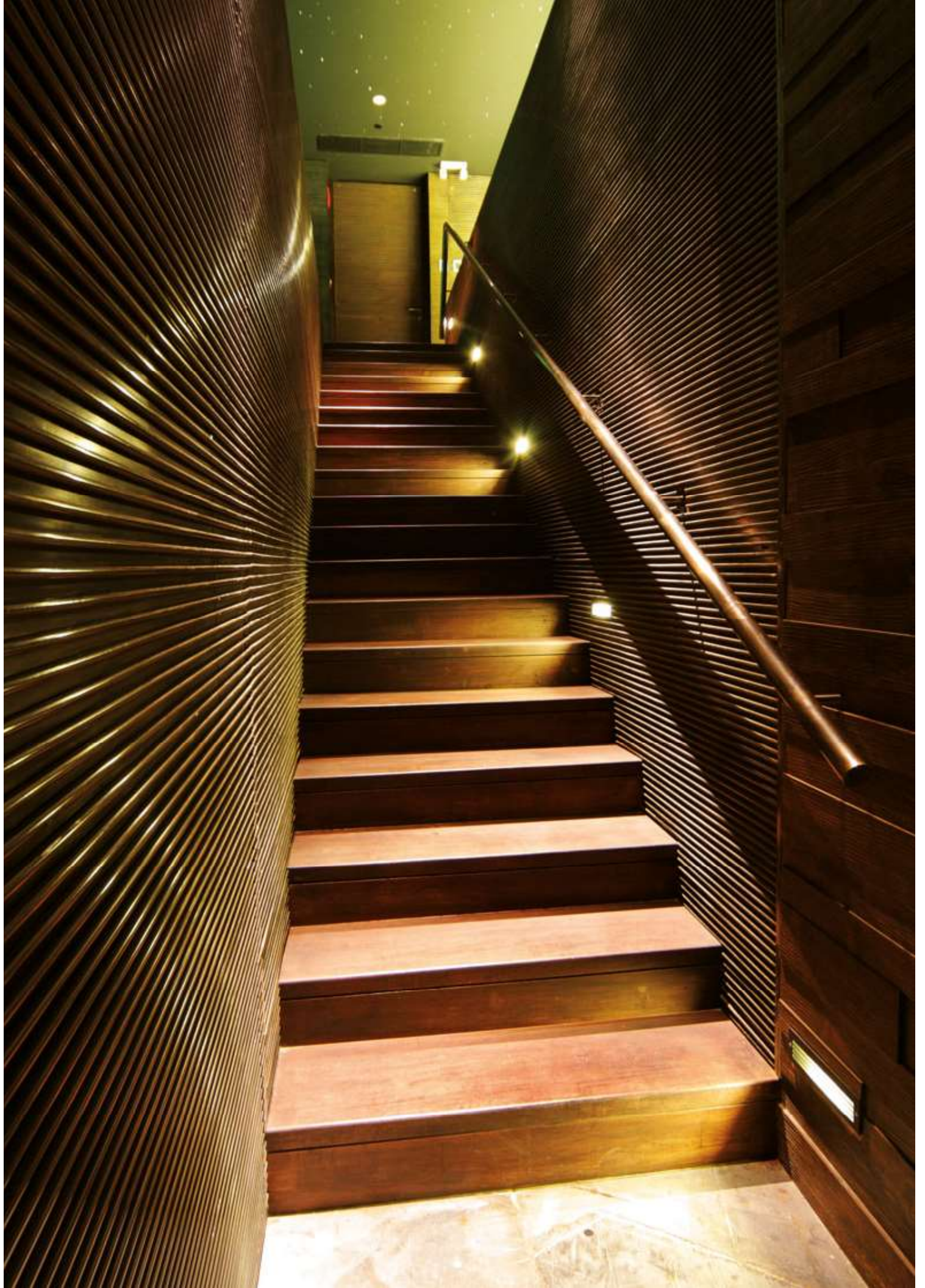





### 502010 HYDROSTEP – LINEAR 01 - LED

Recessed linear steplight for outdoor installation in the wall, phospho-chromatised and polyester powder coated die-cast copper-free aluminium body, stainless steel frame, tempered frosted glass diffuser, polypropilene housing for recess, moulded silicone gasket and stainless steel screws. Built-in LED driver 220-240V 50-60Hz, with 54 low-power SMD3528 LED. IP65 rating.



#### Energy Label **A++**

- Material: high corrosion resistance die-cast copper-free aluminum body
- Coating: polyester powder coating with phosphochromating pre-finish
- Stainless steel AISI 304 frame.
- NR. 54 x SMD3528 LED
- Electronic transformer 220/240V 50/60Hz included
- Stainless steel screws
- Silicone rubber gasket
- Tempered safety fully frosted glass.
- Protection against impact IK09 (10 joule)
- Polypropilene recessing box included.
- 0.5 mt. neoprene power cable included

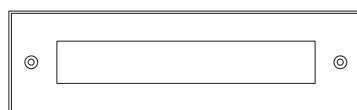

76 mm

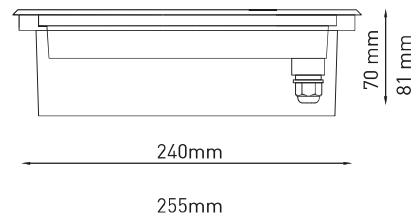

70 mm  
81 mm

240mm

255mm

	LIGHT SOURCE	LED COLOR*	LIGHT BEAM OPTIONS	LUMEN OUTPUT (lm)	LUMINOUS EFFICACY (lm/w)	COLORS OPTIONS
7 WATT 220-240V 50-60HZ ELECTRONIC IP65 1.20 KG UNIT GROSS WEIGHT	SMD3528 LED	3,000°K WARM-WHITE	100°	140	20.00	STAINLESS STEEL

### 502011 HYDROSTEP – LINEAR 02 - LED

Recessed linear steplight for outdoor installation in the wall, phospho-chromatised and polyester powder coated die-cast copper-free aluminium body, stainless steel frame and grid, tempered frosted glass diffuser, polypropilene housing for recess, moulded silicone gasket and stainless steel screws. Built-in LED driver 220-240V 50-60Hz, with 54 low-power SMD3528 LED. IP65 rating.



#### Energy Label **A++**

- Material: high corrosion resistance die-cast copper-free aluminum body
- Coating: polyester powder coating with phosphochromating pre-finish
- Stainless steel AISI 304 frame.
- NR. 54 x SMD3528 LED
- Electronic transformer 220/240V 50/60Hz included
- Stainless steel screws
- Silicone rubber gasket
- Tempered safety fully frosted glass.
- Protection against impact IK09 (10 joule)
- Polypropilene recessing box included.
- 0.5 mt. neoprene power cable included

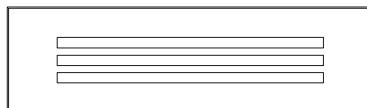

76 mm

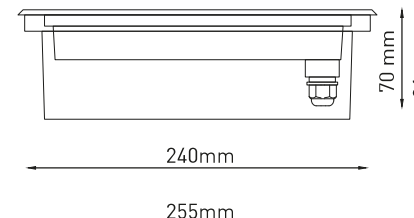

70 mm  
81 mm

240mm

255mm

	LIGHT SOURCE	LED COLOR*	LIGHT BEAM OPTIONS	LUMEN OUTPUT (lm)	LUMINOUS EFFICACY (lm/w)	COLORS OPTIONS
7 WATT 220-240V 50-60HZ ELECTRONIC IP65 1.20 KG UNIT GROSS WEIGHT	SMD3528 LED	3,000°K WARM-WHITE	100°	80	11.43	STAINLESS STEEL