

**101014 HYDROCASE MAXI-20 LED**

Square floodlight for outdoor installation on a façade/wall. Phospho-chromatised and polyester powder coated die-cast copper-free aluminium body, tempered safety glass, moulded silicone gasket and stainless steel screws. built-in LED driver 220-240V 50-60Hz, with 20 CREE XP-G2 LED. IP65 rating.

**Energy Label** A++

- Material: high corrosion resistance die-cast copper-free aluminum body
- Coating: polyester powder coating with phosphochromating pre-finish
- NR. 20 x 1.5W CREE "XP-G2" LED
- Electronic transformer 220/240V 50/60Hz included
- Stainless steel screws
- Silicone rubber gasket
- Tempered safety glass.
- Double nickel-plated brass cable gland PG11
- 1 mt, neoprene power cable included

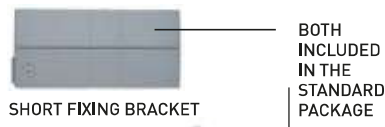

BOTH INCLUDED IN THE STANDARD PACKAGE

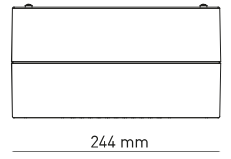
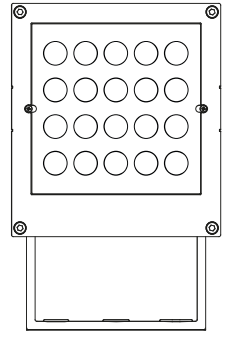
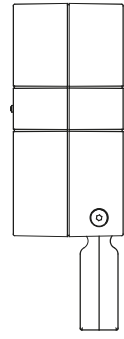

30 WATT  
220-240V 50-60HZ ELECTRONIC  
IP65  
5,50 KG UNIT GROSS WEIGHT

LIGHT SOURCE	LED COLOR*	LIGHT BEAM OPTIONS	LUMEN OUTPUT (lm)	LUMINOUS EFFICACY (lm/w)	COLORS OPTIONS
HIGH-POWER LED	3.000°K WARM-WHITE	10°	2.880	96.00	<input checked="" type="checkbox"/> TEXTURED GREY  <input type="checkbox"/> MATT WHITE (ON REQUEST)  <input checked="" type="checkbox"/> MATT BLACK (ON REQUEST)
		30°	2.736	91.20	
		45°	2.600	86.67	
	6.000°K COLD-WHITE	10°	3.000	100.00	
		30°	2.850	95.00	
		45°	2.708	90.26	

\* OTHER LIGHT COLORS AVAILABLE ON REQUEST: ○ 4.000°K NEUTRAL-WHITE, ● BLUE

**101010 HYDROCASE MAXI G12**





Square floodlight for outdoor installation on a façade/wall. Phospho-chromatised and polyester powder coated die-cast copper-free aluminium body, tempered safety glass, moulded silicone gasket and stainless steel screws. Built-in ballast 220V 50Hz, G12 35W or 70W metal halide. IP65 rating.

- Material: high corrosion resistance die-cast copper-free aluminum body
- Coating: polyester powder coating with phosphochromating pre-finish
- HIT CRI 35W G12 or HIT CRI 70W G12
- Conventional ballast 230V 50Hz
- Stainless steel screws
- Silicone rubber gasket
- Tempered safety glass.
- Nickel-plated brass cable gland PG11

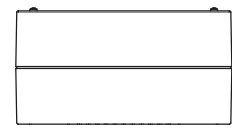
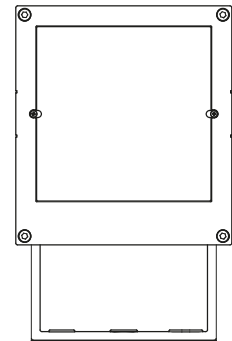
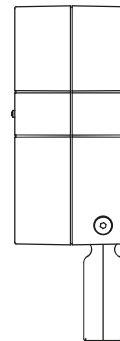

BOTH INCLUDED IN THE STANDARD PACKAGE







	LIGHT SOURCE	LIGHT COLOR	LIGHT BEAM OPTIONS	COLORS OPTIONS
35 WATT   70 WATT HIT-CRI - BASE G12 230V 50HZ IP65 5.20 KG UNIT GROSS WEIGHT	 HIT-CRI - BASE G12	SEE BULB FEATURES	 4° SUPER-NARROW (ON REQUEST)	 TEXTURED GREY
			 10° NARROW	 MATT WHITE (ON REQUEST)
			 23° FLOOD (ON REQUEST)	 MATT BLACK (ON REQUEST)

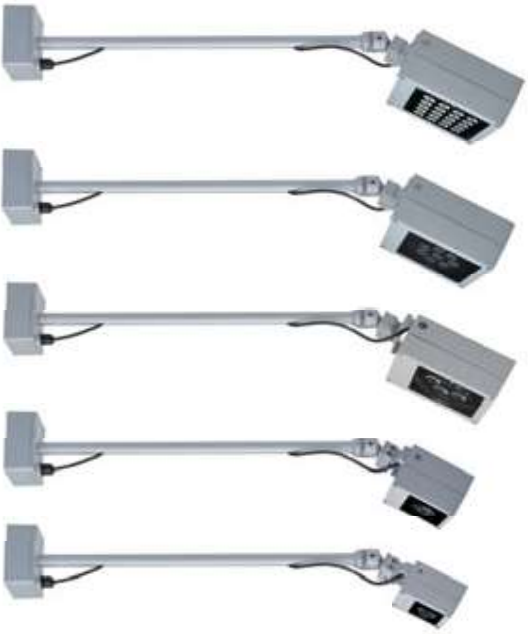

**AC022 IP65 WALL-BASE WITH BRACKET**

- High corrosion resistance die-cast aluminum body and bracket
- Polyester painting with phosphochromating pre-finish
- Stainless steel screws
- Silicone rubber gasket
- Double nickel-plated brass
- Cable gland PG11



COLORS OPTIONS	
	TEXTURED GREY
	MATT WHITE <i>(ON REQUEST)</i>
	MATT BLACK <i>(ON REQUEST)</i>

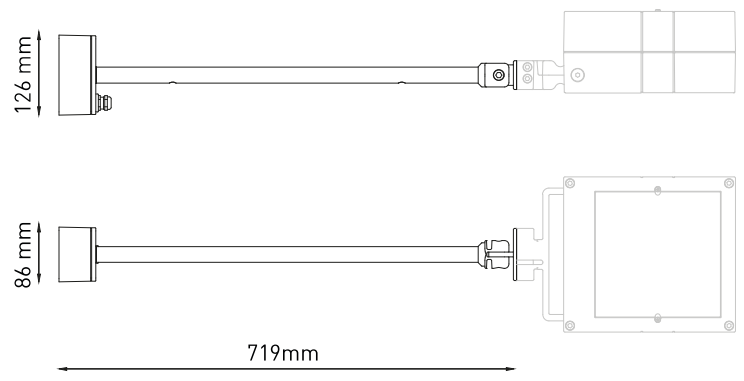





**102001 HYDROPOWER MINI LED**

Square floodlight for outdoor installation on a façade/wall. Phospho-chromatised and polyester powder coated die-cast copper-free aluminium body, tempered safety glass, moulded silicone gasket and stainless steel screws. built-in LED driver 220-240V 50-60Hz, with 16 high-power LED. IP65 rating.

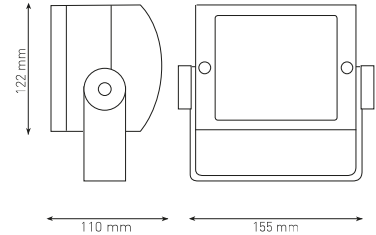
**Energy Label** A++

- Material: high corrosion resistance die-cast copper-free aluminum body
- Coating: polyester powder coating with phosphochromating pre-finish
- 20W High-power LED
- Electronic transformer 220/240V 50/60Hz included
- Stainless steel screws
- Silicone rubber gasket
- Tempered safety glass.
- 1 mt. neoprene power cable included







	LIGHT SOURCE	LED COLOR*	LIGHT BEAM OPTIONS	LUMEN OUTPUT (lm)	LUMINOUS EFFICACY (lm/w)	COLORS OPTIONS
20 WATT 220-240V 50-60HZ ELECTRONIC IP65 2.00 KG UNIT GROSS WEIGHT	HIGH-POWER LED	 3.000°K WARM-WHITE	 20°	1.600	80.00	 MATT WHITE

**102002P HYDROPOWER MINI G8.5**

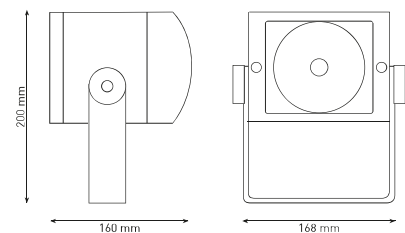
Square floodlight for outdoor installation on a façade/wall. Phospho-chromatised and polyester powder coated die-cast copper-free aluminium body, tempered safety glass, moulded silicone gasket and stainless steel screws. Built-in ballast 220-240V 50-60Hz, G8.5 20W metal halide. IP65 rating.

- Material: high corrosion resistance die-cast copper-free aluminum body
- Coating: polyester powder coating with phosphochromating pre-finish
- HIT-TC CRI 20W G8.5
- Electronic ballast 220/240V 50/60Hz included
- Stainless steel screws
- Silicone rubber gasket
- Tempered safety glass.
- 1 mt. neoprene power cable included



	LIGHT SOURCE	LIGHT COLOR	LIGHT BEAM OPTIONS	COLORS OPTIONS
20 WATT MAX 220-240V 50-60HZ IP65 1,90 KG UNIT GROSS WEIGHT	 HIT-TC CRI 20W G8.5	SEE BULB FEATURES	 5° NARROW   30° FLOOD (ON REQUEST)	 MATT WHITE