

The world's favourite lock



YALE DOOR HARDWARE

IDEAL GUIDE FOR LOCKSMITHS,
OEM & SEMI-COMMERCIAL FOCUS.

Contents

The History of Yale **4**

Hydraulic Door Closer Series

Yale Y2600 Series Size 2-6 **5**
Power Adjustable Hydraulic Door Closer

Yale Y2400 Series Size 2-4 **6**
Adjustable Power Hydraulic Door Closer

Yale Y300 Series Hydraulic Door Closer **7**

Yale Y300 OP Series Hydraulic Door Closer **8**

Hinged Door Locks

Yale Key in Knob/Key in Lever **9**

Yale Accessories **12**

Yale Deadbolts **13**

Short Backset Mortice Locks

Short Backset Mortice Locks **14**

The History of Yale

The world's favourite lock



Yale is one of the oldest international brands in the world and one of the best-known names in the locking industry. The Yale history captures major innovations that have marked the evolution not just of Yale, but of the entire locking industry.

Beginnings

Yale has its roots in colonial America. The Yale family decided to emigrate to the New World from North Wales. A few generations later, about 1840, Linus Yale Sr., began designing and manufacturing a series of innovative, high security locks at his Yale Lock Shop in Newport, New York. He specialized in expensive, handmade bank locks.

Pioneer innovations

Linus Yale Sr.'s son joined his father in the business in 1850 and perfected and patented his father's pin tumbler cylinder lock and became the considered locking expert of his time. In 1862, Yale Jr. introduced the Monitor Bank Lock, marking the transition in bank locks from key locks to dial or combination locks. The principles, embodied in his Monitor Lock, are now standard in combination locks throughout the USA.

Yale Jr.

Yale Jr. was also experimenting with a lock based on a mechanism first employed by the ancient Egyptians over 4,000 years ago. Granted patents in 1861 and 1865, Yale

finally succeeded in creating his most important invention – the Yale cylinder lock. Linus Yale Jr. transformed the locking industry forever with his many breakthrough inventions.

Worldwide expansion

Relying on Yale patents, Yale's sterling name and sheer ingenuity, Yale Jr. and his colleague Henry Towne established the Yale & Towne company in 1868, at the time employing 35 people.

The company grew and broadened its scope with manually operated chain hoists, battery powered platform trucks and in 1879 a line of padlocks was introduced. Yale & Towne purchased Norton door closer company and H. and T. Vaughan Ltd.

In the early 20th century, the company expanded worldwide and employed more than 12,000 people. Throughout the 20th century, purchases, acquisitions and joint ventures with brands as Guli, Chubb Locks, Parkes and C E Marshall have made Yale locks well-known worldwide.

In August 2000 Yale was purchased by the ASSA ABLOY Group, and has since then been an important part of the global leader in door opening solutions.

Hydraulic Door Closer Series

Yale Y2600 Series Power Adjustable Hydraulic Door Closer

The world's favourite lock



The Yale Y2600 Series is the complete door closer in one. It will cater for a wide range of applications, with power adjustment from sizes 2 to 6, built-in delayed action and backcheck makes this door closer ideally suited for exterior doors and installations affected by adverse weather conditions. Slim neat design will complement most applications. Each pack contains a standard Parallel Arm Bracket.

Adjustable Power

Closer spring power is adjustable for sizes 2 to 6.

Backcheck

Standard in this series.

Delayed Action

Independent valve control between 180° – 80° closing. Ideally suited for disabled door applications.

Materials

High pressure diecast aluminium body. Heat treated steel rack and pinion. Forged steel arms passivated against corrosion.

Overload Protection

A built-in pressure relief valve protects the closer against rough use.

Slide Arm

Available in this series.

Aesthetically appealing with lower opening force.

Hold-open

Available in this series.

Hold-open between 80° – 180°. Order arm assembly separate.

Handing

Non-handed.

Adjustment

Two control valves (latching and closing).

Drop Plate

Available in this series. Y2600 - 180SIL.

Finish

Silver Baked Enamel – SIL

FIRE RATED

This Yale Door Closer has been successfully fire tested up to 2 hours on fire door assemblies in accordance with Australian Standard AS1905.1:2005 - Part 1: Fire Resistant Door sets.

NOTE: Hold-open option is not approved on any fire door.



Ordering - Trade Pack

| Part Number | Description |
|--------------|--------------------------|
| Y2600SIL | DOOR CLOSER ADJ 2-6 |
| Y2600-431SIL | SLIDE ARM ASSY |
| Y2600-224SIL | HOLD OPEN ARM |
| Y2600-180SIL | DROP PLATE |
| Y2600-157SIL | "L" PARALLEL ARM BRACKET |

Regular Arm

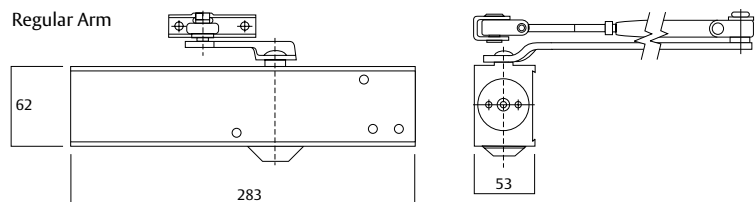

Slide Arm

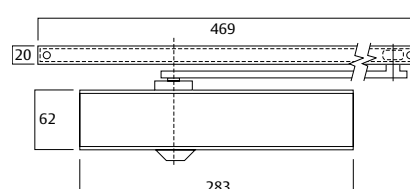

Hydraulic Door Closer Series

Yale Y2400 Series Power Adjustable Hydraulic Door Closer

The world's favourite lock



The Yale Y2400 Series door closer will cater for a wide range of applications and door sizes. Ideally suited to doors in low to medium traffic areas. With power adjustment range from 2-4 strength. Slim neat design will complement most applications. Each pack contains a standard Type Parallel Arm Bracket.

Adjustable Power

Closer spring power is adjustable for sizes 2-4.

Materials

High pressure diecast aluminium body. Heat treated steel rack and pinion. Forged steel arms passivated against corrosion.

Backcheck

Standard on this model.

Mechanism

Rack and pinion.

Overload Protection

A built-in pressure relief valve protects the closer against rough use.

Slide Arm

Available in this series.

Aesthetically appealing with lower opening force.

Hold-open

Available in this series. Hold-open between 80° – 180°.

Order arm assembly separate.

Handing

Non-handed. Suitable for left or right hand doors.

Adjustment

Two control valves (latching and closing).

Drop Plate

Available in this series. Y2400-180SIL.

Finish

Silver Baked Enamel – SIL

FIRE RATED

This Yale Door Closer has been successfully fire tested up to 2 hours on fire door assemblies in accordance with Australian Standard AS1905.1:2005 - Part 1: Fire Resistant Door sets.

NOTE: Hold-open option is not approved on any fire door.



Ordering - Trade Pack

| Part Number | Description |
|--------------|----------------------|
| Y2400SIL | DOOR CLOSER SIZE 2-4 |
| Y2400-431SIL | SLIDE ARM ASSY |
| Y2400-224SIL | HOLD OPEN ARM |
| Y2400-180SIL | DROP PLATE |
| Y2400-157SIL | "L" PARALLEL BRACKET |

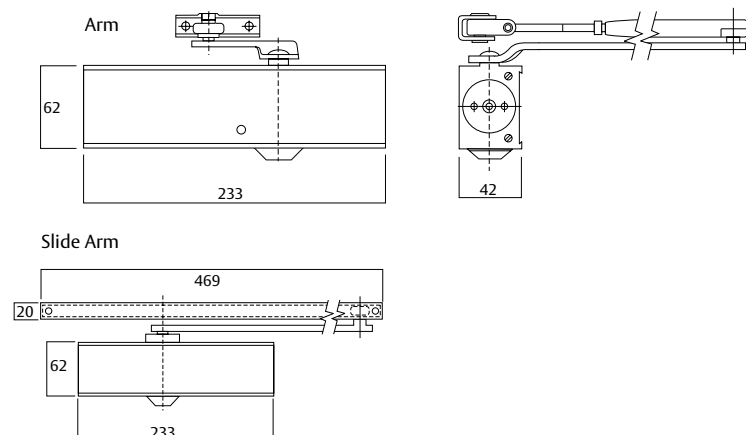

Hydraulic Door Closer Series

Yale Y300 Series Hydraulic Door Closer

The world's favourite lock



The Yale Y300 Series provides a full range of economy surface mounted door closers which covers a wide range of applications. Three Power sizes to suit most pull side applications where economy and ease of installation are required.

Installation

Pull side application only.

Power Sizes

Fixed power size range of 3, 4, 5.

Materials

High purity die-cast aluminium body. Heat treated steel rack and pinion. Stable hydraulic oil for consistent climatic operation and constant lubrication. Forged steel arms passivated against corrosion.

Mechanism

Rack and pinion.

Hold-open

Available in this series.

Hold-open angle between 80° – 180°.

Order arm assembly separate.

Handing

Non-handed. Suitable for left or right hand doors.

Adjustment

Independent valves control closing and latching speeds.

Closing speed 180° – 10°.

Latching speed 10° – 0°.

Finish

Silver Baked Enamel – SIL



Ordering - Trade Pack

| Part Number | Description |
|--------------|---|
| Y300-STSL | SIZE 3 STANDARD ARM DOOR CLOSER |
| Y400-STSL | SIZE 4 STANDARD ARM DOOR CLOSER |
| Y500-STSL | SIZE 5 STANDARD ARM DOOR CLOSER |
| Y2400-224SIL | HOLD OPEN ARM ASSY TO SUIT Y300-STSL |
| Y2600-224SIL | HOLD OPEN ARM ASSY TO SUIT Y400-STSL, Y500-STSL |

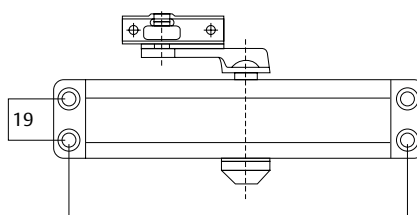

208mm Size 3
230mm Size 4-5

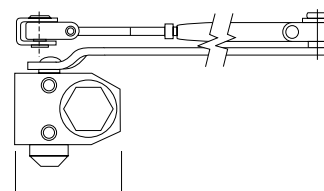

73mm size 3
77mm size 4-5

Hydraulic Door Closer Series

Yale Y300 OP Series Hydraulic Door Closer

The world's favourite lock



The Yale Y300 OP Series provides a full range of economy surface mounted door closers which covers a wide range of applications. Three Power sizes to suit most push side applications where economy and ease of installation are required.

Installation

Push side application only.

Power Sizes

Fixed power size range of 2, 3, 4.

Materials

High purity die-cast aluminium body. Heat treated steel rack and pinion. Stable hydraulic oil for consistent climatic operation and constant lubrication. Forged steel arms passivated against corrosion.

Mechanism

Rack and pinion.

Handing

Non-handed. Suitable for left or right hand doors.

Adjustment

Independent valves control closing and latching speeds.

Closing speed 180° – 10°.

Latching speed 10° – 0°.

Offset Parallel Arm

Suits up to 13mm door stop.

Finish

Silver Baked Enamel – SIL



Ordering - Trade Pack

| Part Number | Description |
|-------------|--|
| Y300-OPSIL | SIZE 2 OFFSET PARALLEL ARM DOOR CLOSER |
| Y400-OPSIL | SIZE 3 OFFSET PARALLEL ARM DOOR CLOSER |
| Y500-OPSIL | SIZE 4 OFFSET PARALLEL ARM DOOR CLOSER |

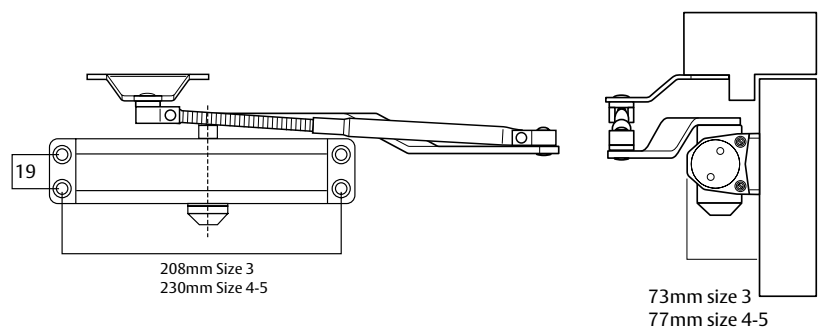

Hinged Door Locks

Key in Knob/Key in Lever

The world's favourite lock



The Yale Commercial Series Locksets incorporate a cylindrical chassis design housing a PD cylinder. Available in both lever and knob designs with a range of cylinder and latch options, the Yale Commercial Series offers a wide range of functions to accommodate a broad range of applications.

For added security it is recommended that Yale Commercial Series Knob and Lever Locksets are used in conjunction with Yale Commercial Deadbolts.

Knob/Lever Designs

YK (Knob) and YL (Lever) design

Backset

Standard 60mm backset for key in knob and 70mm backset for key in lever.

Latch

Stainless steel latch bolt.

Cylinder

Standard "PD" type cylinder keyed to C4 profile with two keys.

Door Thickness

Knob suits door thickness 32 – 46mm.
Lever suits door thickness 35 – 46mm.

Finishes

Standard finish Satin Stainless Steel on Knob series and Satin Chrome Brushed on Lever series.

Standard Keying

- Supplied individually keyed with two keys per lock
- 78,000 key combinations
- Key blanks:
 - V06 5PIN C4 (Standard)
 - V07 6PIN C4

Restricted Special Keying

Yale Commercial locks can be keyed to a number of controlled and/or specially keyed systems. These range from legally protected keys to protect against unauthorised duplication, which can also include specially designed key systems such as master key systems, which allow for different levels of mechanical access control.

Please contact your local sales office or customer service for specific information on keying systems.

Handing

Handing is field changeable.



YK1 Series Key in Knob

YL1 Series Key in Lever



Yale Commercial Series cylindrical locksets have been successfully tested up to 2 hours on fire door assemblies in accordance with Australian Standard AS-1905 Part 1, Fire Resistant Doorsets.

Hinged Door Locks

Yale Commercial Key in Knob Locksets

The world's favourite lock



YK16/EXT/SS Exterior Deadlatch

60mm backset

Outside

Opened by knob when unlocked.

Key unlocks exterior knob.

*70mm backset option = YK17/EXT/SS

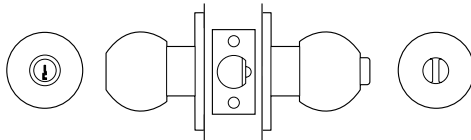

Inside

Opened by knob at all times. Push button locks exterior knob.

YK16/PAS/SS Passage Set

60mm backset

Outside

Opened by knob at all times.

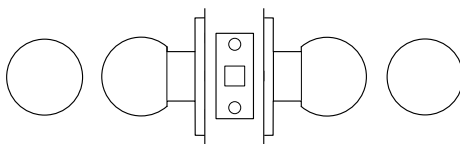

Inside

Opened by knob at all times.

YK16/PRI/SS Privacy Set*

60mm backset

Outside

Opened by knob when unlocked. Coin or screwdriver in emergency button unlocks knob.

*Includes anti-lockout function.

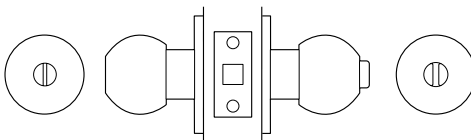

Inside

Opened by knob at all times. Push button locks exterior knob.

YK16/GLA/SS Glassdoor Deadlatch

60mm backset

Outside

Opened by knob when unlocked.

Key locks or unlocks both knobs.

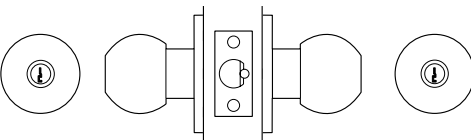

Inside

Opened by knob when unlocked. Key locks or unlocks both knobs.

YK16/DUM/SS Dummy Trim

60mm backset

Outside

For use where only a door pull is required.

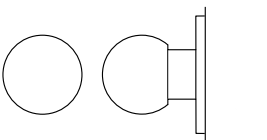

Inside

Available with either concealed or wood screw fixing.

YK16/CLA/SS Classroom Deadlatch

60mm backset

Outside

Opened by knob when unlocked.

Key locks or unlocks exterior knob.

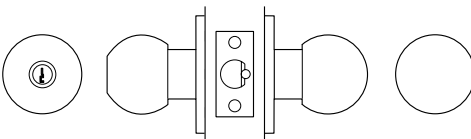

Inside

Opened by knob at all times.

YK16/STO/SS Storeroom Deadlatch

60mm backset

Outside

Opened by key only.

Outside knob is rigid at all times.

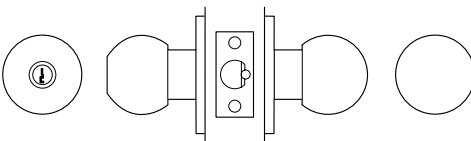

Inside

Opened by knob at all times.

Hinged Door Locks

Yale Commercial Key in Lever Locksets

The world's favourite lock



YL17/EXT/SC Exterior Deadlatch

70mm backset

Outside

Opened by handle when unlocked.
Key unlocks exterior handle.

*60mm backset option = YL16/EXT/SC

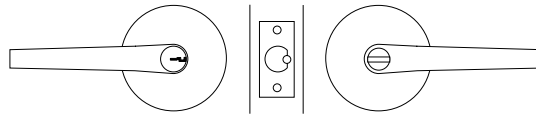

Inside

Opened by handle at all times. Push button locks exterior handle.

YL17/PAS/SC Passage Set

70mm backset

Outside

Opened by handle at all times.

*60mm backset option = YL16/PAS/SC

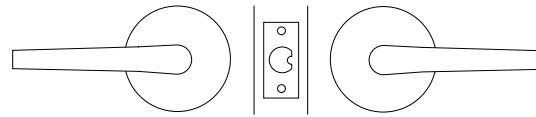

Inside

Opened by handle at all times.

YL17/PRI/SC Privacy Set*

70mm backset

Outside

Opened by handle when unlocked.
Coin or screwdriver in emergency button unlocks handle.

*Includes anti-lockout function.

*60mm backset option = YL16/PRI/SC

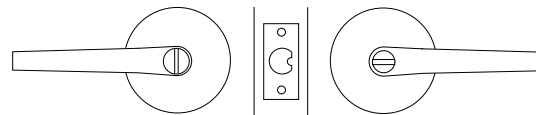

Inside

Opened by handle when unlocked. Push button locks exterior handle.

YL17/GLA/SC Glassdoor Lockset

70mm backset

Outside

Opened by handle when free.
Key locks or unlocks both handles.

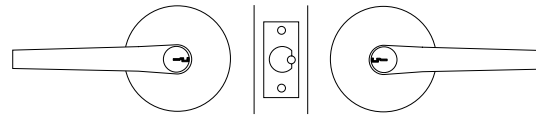

Inside

Opened by handle when free. Key locks or unlocks both handles.

YL17/DUM/SC Dummy Trim

70mm backset

Outside

For use where only a door pull is required.

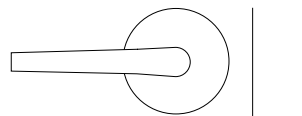

Available with either concealed or wood screw fixing.

YL17/CLA/SC Classroom Set

70mm backset

Outside

Opened by handle when unlocked.
Key locks or unlocks exterior handle.

*60mm backset option = YL16/CLA/SC

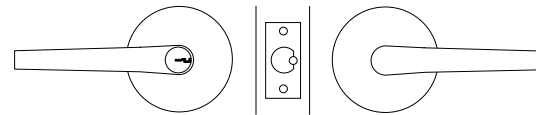

Inside

Opened by handle at all times.

YL17/STO/SC Storeroom Set

70mm backset

Outside

Opened by key only. Outside handle is rigid at all times.

*60mm backset option = YL16/STO/SC

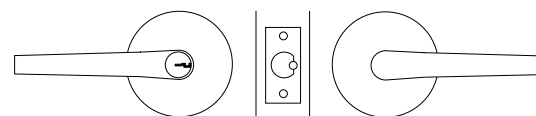

Inside

Opened by handle at all times.

Hinged Door Locks

Yale Commercial Lockset Accessories

The world's favourite lock



Latches



Latches

| | |
|--------------------|--------------|
| Deadlatch 60mm | SPY/DL60/SC |
| Plainlatch 60mm | SPY/PL60/SC |
| Deadlatch 70mm | SPY/DL70/SC |
| Privacy Latch 60mm | SPY/PLP60/SC |

Rebate Kit

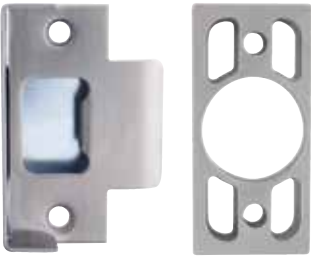

Rebate Kit

| | |
|------------|------------|
| Rebate Kit | SPY/REB/SC |
|------------|------------|

Hinged Door Locks

Yale Commercial Deadbolts

The world's favourite lock



For added security it is recommended that Yale Commercial Deadbolts are used in conjunction with Yale Commercial Series Knob or Lever Locksets.

Single cylinder

Key operation from outside and a turn knob from the inside.

Double cylinder

Key operation from outside and inside.

Backset

Adjustable 60-70mm backset.

Latch

Solid brass bolt with 25mm projection.

Cylinder

Standard "PD" type cylinder keyed to C4 profile.

Door Thickness

35 to 45mm

* Requires spacer ring (included)

Finishes

Single Cylinder:

Satin Chrome Brushed SC

Double Cylinder:

Satin Chrome Brushed SC

Satin Stainless Steel SSS

Keying

Standard Keying

- Supplied individually keyed with two keys per lock
- 78,000 key combinations
- Key blanks:
 - V06 5PIN C4 (Standard)
 - V07 6PIN C4

Restricted Special Keying

Yale Commercial Deadbolts can be keyed to a number of controlled and/or specially keyed systems. These range from legally protected keys to protect against unauthorised duplication, which can also include specially designed key systems such as master key systems, which allow for different levels of mechanical access control.

Please contact your local sales office or customer service for specific information on keying systems.

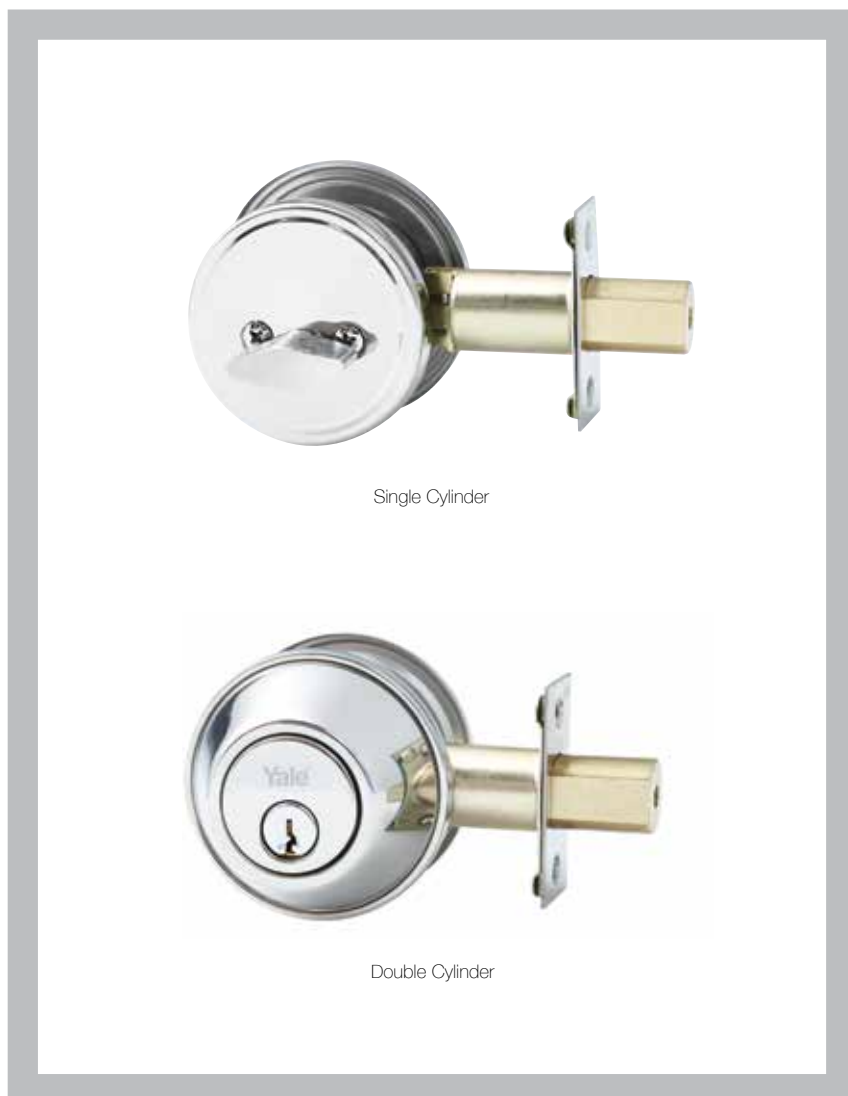

Single Cylinder

Double Cylinder

Ordering - Trade Pack

| Part Numbers | Description |
|--------------|-----------------|
| YDB1/DCYL* | DOUBLE CYLINDER |
| YDB1/SCYL* | SINGLE CYLINDER |

* Denotes surface finish

Short Backset Mortise Locks

The world's favourite lock



The Yale short backset mortise locks are designed and packaged specifically for the commercial metal and frameless glass door fabricator markets.

Application

These 23mm backset deadlocks and sliding door locks are suitable for use on aluminium, or frameless glass doors in industrial and commercial applications. Each lock is supplied with two escutcheons and is available in double cylinder and single cylinder and turn configurations. Deadlocks may also be used with an appropriate patch fitting on frameless glass doors. A trough strike is available for this application.

Deadlocks

A single action bolt with steel case and laminated steel bolt. Available in both 22mm bolt throw and 36mm bolt throw variations. The bolt is positively dogged in both the locked and unlocked position before the key can be withdrawn.

Sliding Door Lock

A similar case and mechanism to the deadlock with a 29mm hook bolt designed to engage in a self-latching strike.

Security

Conforms with level S1 (Physical Security) Australian Lock Standard (Standard No. AS4145.2-1993).

Durability

Conforms with level D3 (Durability) Australian Lock Standard (Standard No. AS 4145.2-1993).

Door Thickness

Minimum door thickness is 30mm (due to the width of the face plate). Maximum door thickness using a standard cylinder and cylinder escutcheons and/or turn is 58mm.

Handing

All functions are fully reversible. Cylinders and turns are fitted on site to suit door handing.

Standard Keying

Supplied individually keyed in "C4" keyway with 2 keys per lock.

Finishes

Satin Chrome (SC)



Hinged Door Deadlocks

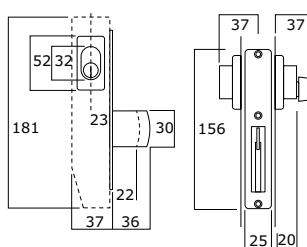

Sliding Door Deadlocks

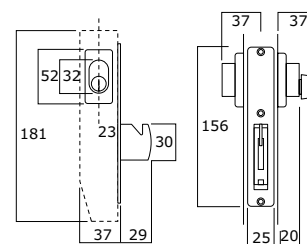

Frameless Glass Trough Strike

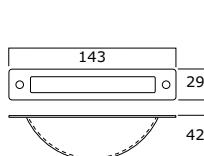

Self-latching Strike (supplied with Sliding Door Deadlocks)

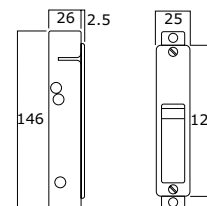

All dimensions are in millimetres.

Y590 Series Short Backset Mortice Deadlocks

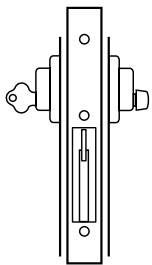

Cylinder and Turnknob Reversible

Outside

Locked or unlocked by key.

Inside

Locked or unlocked by turnknob.

Order Codes

| | |
|---------------|----------|
| 22mm Deadbolt | Y590CTSC |
| 29mm Hookbolt | Y591CTSC |
| 36mm Deadbolt | Y592CTSC |

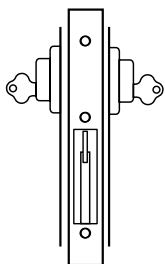

Double Cylinder Reversible

Recommended for glass doors.

Outside

Locked or unlocked by key.

Inside

Locked or unlocked by key.

Order Codes

| | |
|---------------|----------|
| 22mm Deadbolt | Y590CCSC |
| 29mm Hookbolt | Y591CCSC |
| 36mm Deadbolt | Y592CCSC |

Short Backset Mortice Locks

Trough Strike



Accessories

| | |
|---------------------|-------------|
| Cylinder Escutcheon | SPY590-CESC |
| Trough Strike | SP590-353SC |
| Escape Lever Kit | SPY590-ELSC |
| Cylinder Cam | SP590-15ZP |

Cylinder Escutcheon



Escape Lever



Cylinder Cam





The world's favourite lock



The **Yale Brand**, with its unparalleled global reach and range of products, reassures more people in more countries than any other consumer locking solution.

The **ASSA ABLOY** group is the world's leading manufacturer and supplier of locking solutions, dedicated to satisfy user needs for security, safety and convenience.

yalelock.com.au

ASSA ABLOY Australia Head Office
ASSA ABLOY Australia Pty Limited
235 Huntingdale Road, Oakleigh
Victoria, 3166 Australia

1300 LOCK UP (1300 562 587)
info.au@assaabloy.com
assaabloy.com.au

